

# Product Data Sheet

## NSB 60FT Silver



Specifically designed  
for semi-stable  
mains applications



- Long design life
- High cycling and fast recharge performance
- State of the art manufacturing automation ensures consistency and reliability
- Advanced 3 stage terminal design to ensure leak free operation
  - Female M8 brass terminals provide maximum performance
- High modulus polyphenylene plastic materials designed to withstand extended elevated operating temperatures and maintain high battery compression essential for reliable operation
- Thermally sealed plastic casing and cover
  - Flame retardant (UL 94 VO) and LOI of at least 28%
- Integral handles and front access terminals ensure ease of installation and maintenance
- 2 year shelf life at 25°C (77°F)
- Approved as non-hazardous cargo for ground, sea, and air transport
  - DOT 49CFR173.159(d), (i) and (ii)



# Product Data Sheet

## NSB 60FT Silver



### Technical Specifications

	International Standards 20°C (68°F)	NA Standards 77°F (25°C)
8 hour capacity to 1.75 Volts/Cell	57 Ah	58 Ah
10 hour capacity to 1.80 Volts/Cell	57 Ah	58 Ah
Float Voltage	2.29 +/- 0.02 Volts/Cell	2.27 +/- 0.02 Volts/Cell
Nominal Voltage	12 V	
Impedance (1kHz)	4.3 mΩ @ 25 °C (77 °F)	
Conductance	1063 S	
Short Circuit Current	2,100 A	

### Measurements

Height	263 mm (10.4 in)
Width	108 mm (4.2 in)
Depth	287 mm (11.3 in)
Weight	22 kg (48 lbs)
Terminal	Female M8 leak proof
Terminal Torque	8.0 Nm (71 in-lbs)

### Ah Capacity Ratings at 25°C (77°F)

Capacity discharge (hours)	1	2	4	8	10
Capacity @ 25°/Ah	43	48	54	58	58
End of discharge (Volts)	1.70	1.75	1.75	1.75	1.80

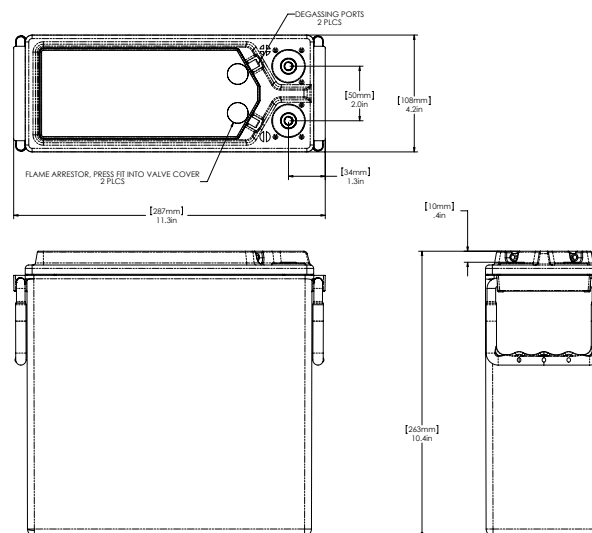

NorthStar in the Americas  
 NorthStar Battery Company LLC  
 4000 Continental Way  
 Springfield, MO 65803  
 USA  
 Tel: (+1) 417 575 8200  
 Fax: (+1) 417 575 8250  
 info@northstarbattery.com  
 www.northstarbattery.com

NorthStar in Europe, Africa,  
 Middle East  
 SiteTel Sweden AB  
 Staffans Väg 6-8  
 Box 7039  
 SE-192 07 Sollentuna  
 Sweden  
 Tel. +46 8 410 102 00  
 Fax. +46 8 638 06 00  
 europe@northstarbattery.com

NorthStar in Asia-Pacific  
 SiteTel Shanghai Co Ltd  
 Building 9, 1201 Gui Qiao Road  
 Jin Qiao Export Process Zone  
 201206 Shanghai  
 China  
 Tel. +86 21 5899 7610  
 Fax. +86 21 3872 2201  
 asia@northstarbattery.com



Form: SES-542-02-03 Issued: 10-13-10 ECO: 1374-S10

#### All NorthStar products are compliant with:

- Telcordia SR4228, Bellcore GR-63-Core, Issue 1
- British, German, and Russian telecom standards
- UL Approved

NorthStar is Registered to ISO 9001 & ISO 14001