



MODEL: IND17-6V
DIMENSIONS: inches (mm)
BATTERY: Flooded/wet lead-acid battery
COLOR: Maroon (case/cover)
MATERIAL: Polypropylene (internal cell container)
 Polyethylene (outer container)

PRODUCT SPECIFICATION

TYPE	CAPACITY ^A Amp-Hours (AH)								ENERGY (kWh)	VOLTAGE	DIMENSIONS ^B Inches (mm)			WEIGHT lbs. (kg)	
	5-Hr Rate	10-Hr Rate	20-Hr Rate	48-Hr Rate	72-Hr Rate	100-Hr Rate	240-Hr Rate	100-Hr Rate			Length	Width	Height ^C	Dry	Wet
DEEP CYCLE BATTERY															
IND17-6V	711	805	897	1011	1061	1090	1101	6.54	6	26-11/16 (678)	10-1/4 (260)	24 (610)	331 (150)	415 (188)	

A. The amount of amp-hours (AH) a battery can deliver when discharged at a constant rate at 80°F (27°C) and maintain a voltage above 1.75 V/cell. Capacities are based on nominal performance.

B. Dimensions are based on nominal size. Dimensions may vary depending on type of handle or terminal.

C. Dimensions taken from bottom of the battery to the highest point on the battery. Heights may vary depending on type of terminal.

Trojan's battery testing procedures adhere to both BCI and IEC test standards.

CAPACITY AMP-HOURS (AH)

Cutoff Voltage	5-Hr	10-Hr	20-Hr	48-Hr	72-Hr	100-Hr	240-Hr
1.75 vpc	711	805	897	1011	1061	1090	1101
1.80 vpc	641	757	861	991	1041	1067	1085
1.85 vpc	581	684	791	911	971	1006	1009
1.90 vpc	424	550	661	801	861	894	901

CHARGING INSTRUCTIONS

CHARGER VOLTAGE SETTINGS (AT 77°F/25°C)	
	Voltage per cell
Absorption charge	2.35-2.45
Float charge	2.20
Equalize charge	2.58

Do not install or charge batteries in a sealed or non-ventilated compartment. Constant under or overcharging will damage the battery and shorten its life as with any battery.

OPERATIONAL DATA

Operating Temperature	Self Discharge	Specific Gravity
-4°F to 113°F (-20°C to +45°C). At temperatures below 32°F (0°C) maintain a state of charge greater than 60%.	Up to 4% per week	The specific gravity at 100% state-of-charge is 1.260

CHARGING TEMPERATURE COMPENSATION

To the Voltage Reading -- Subtract 0.005 volt per cell (VPC) for every 1°C above 25°C or add 0.005 volt per cell for every 1°C below 25°C.

EXPECTED LIFE VS. TEMPERATURE

Chemical reactions internal to the battery are driven by voltage and temperature. The higher the battery temperature, the faster chemical reactions will occur. While higher temperatures can provide improved discharge performance the increased rate of chemical reactions will result in a corresponding loss of battery life. As a rule of thumb, for every 10°C increase in temperature the reaction rate doubles. Thus, a month of operation at 35°C is equivalent in battery life to two months at 25°C. Heat is an enemy of all lead acid batteries, FLA, GEL, and AGM alike and even small increases in temperature will have a major influence on battery life.

TROJAN IND17-6V PERFORMANCE

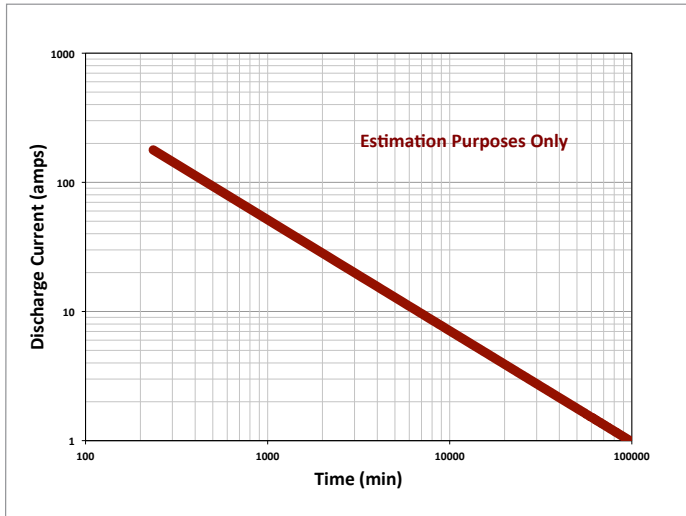

CYCLE LIFE

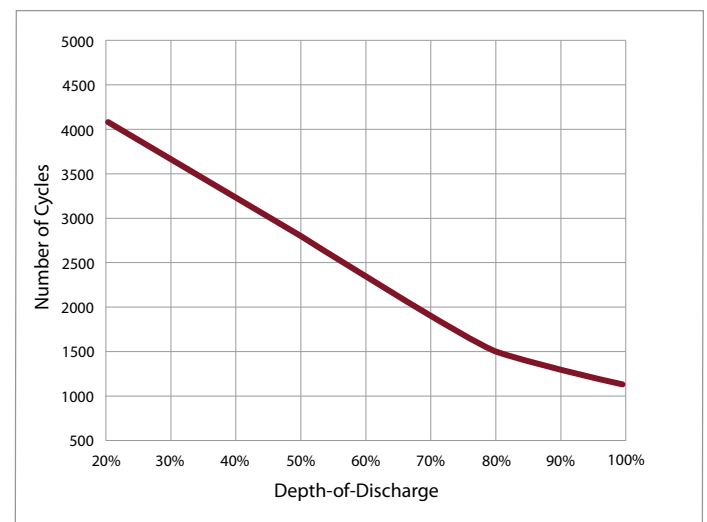

CAPACITY VS. TEMPERATURE

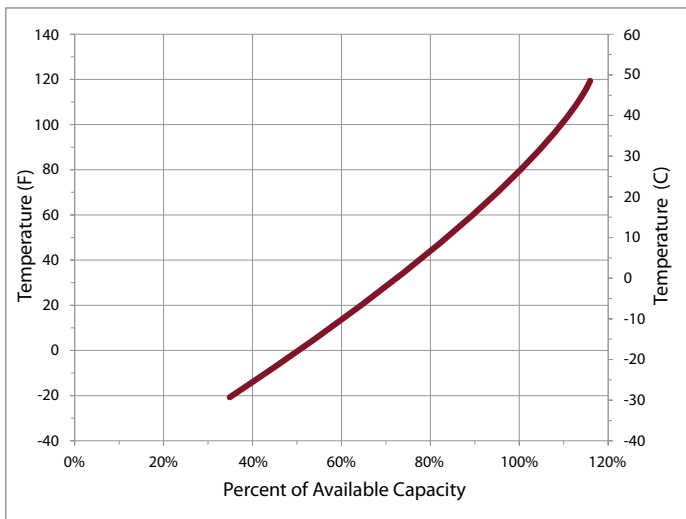

BATTERY DIMENSIONS

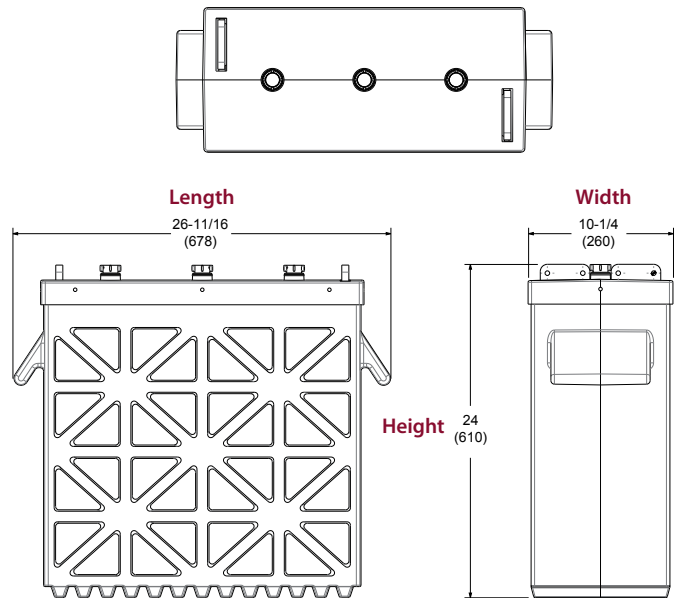

TERMINAL CONFIGURATIONS

14	IND	Ind Terminal
		
Terminal Height Inches (mm) 1-3/4 (44)		
Torque Values LB-IN (Nm) 100 - 120 (11 - 14)		
Through-hole Diameter Inches (mm) 3/8 (9.5)		

VENT CAP OPTIONS

